

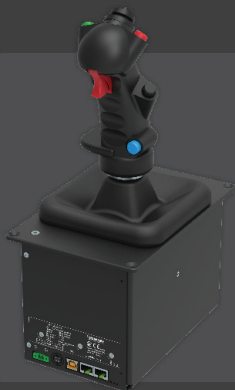

CLS-E JOYSTICK QUICKSTART MANUAL



LANGUAGES

Englisch	2
Deutsch	8
Français	13
Italiano	21
Español	26



TABLE OF CONTENT CLS-E JOYSTICK ENGLISH

1 SAFETY AND WARNING INFORMATION	3
2 INSTALLATION INSTRUCTIONS	4
3 GRIP INSTALLATION	5
4 SOFTWARE INSTALLATION	6
5 TECHNICAL DATA AND DISPOSAL NOTES	7
6 WIRING DIAGRAM	32

RANGE OF APPLIANCE USE. THE APPLIANCE IS ONLY FOR SIMULATION OF CONTROL PRESSURES AND CONTROL OF AN AIRCRAFT IN A FLIGHT SIMULATION IN CONNECTION WITH A PC FOR HOME USER. FURTHERMORE, THE APPLIANCE IS UNSUITED FOR USE IN AREAS EXPOSED TO AN EXPLOSION HAZARD.

GENERAL. THE CORRECT AND SAFE OPERATION OF THE UNIT IMPLIES IT'S PROPER AND PROFESSIONAL TRANSPORT, STORAGE, ASSEMBLY AND CAREFUL OPERATION AND MAINTENANCE.

HANDLE WITH CARE. DO NOT DROP. DISCONNECT POWER AND COMMUNICATION CABLES BEFORE MOVING.

WARNING! KEEP THE STICK AREA CLEAR WHEN POWER IS APPLIED. WAIT UNTIL INIT- SEQUENCE IS FINISHED (NO MOVING) BEFORE TOUCHING THE GRIP.

WARNING! KEEP ANIMALS AWAY FROM THE SYSTEM!

WARNING! THE CLS-E JOYSTICK IS NOT A TOY. SMALL CHILDREN UNDER 16 YEARS SHOULD NOT OPERATE THE JOYSTICK WITHOUT SUPERVISION OF AN ADULT. DEPENDING ON THE SETTINGS, OR IN CASE OF FAILURE, AXIS CAN MOVE IN ANY DIRECTION AND WITHOUT WARNINGS.

WARNING! DO NOT REMOVE THE COVER. THE UNIT MUST NOT BE OPERATED WITHOUT COVER (PROTECTIVE HOODS)!

WARNING! OPERATION WITHOUT A PERMANENTLY INSTALLED STICK GRIP HANDLE IS NOT ALLOWED!

WARNING! THE UNIT MUST BE MOUNTED SECURELY ON A FLAT STABLE SURFACE BEFORE OPERATING!

POWER SUPPLY WARNING! CAUTION ELECTRIC SHOCK/FIRE HAZARD!

DO NOT USE ANY OTHER POWER SUPPLY, AS THE ONE SUPPLIED BY BRUNNER, WITH YOUR CLS-E JOYSTICK.

TO PREVENT ELECTRIC SHOCK, MAKE SURE THAT THE SOCKET IS PROPERLY EARTHED AND PROTECTED BY A FUSE.

WARNING ENVIRONMENT! FOR INDOOR USE ONLY. DO NOT EXPOSE TO MOISTURE, LIQUID, OR HEAT.

NO REPAIR OR OPENING. THE JOYSTICK IS DESIGNED FOR LIFETIME LUBRICATION.

WARNING! BEFORE ALLOWING THIRD-PERSON OPERATING THE HARDWARE, MAKE SURE THAT THIS THIRD-PERSON READ ALL WARNINGS, UNDERSTOOD AND ACCEPTED.

IMPORTANT ERGONOMIC INFORMATION. LONG PERIODS OF REPETITIVE MOTION USING AN IMPROPERLY SET-UP WORKSPACE, INCORRECT BODY POSITION, AND POOR WORK HABITS MAY BE ASSOCIATED WITH PHYSICAL DISCOMFORT AND INJURY TO NERVES, TENDONS, AND MUSCLES.

NON-OBSERVANCE OF THESE INSTRUCTIONS MIGHT RESULT IN FAILURES OR IN CASE OF MALFUNCTIONS IN INJURIES!



GENERAL

Open the box carefully and remove all packaging.
The following material is included:

1. CLS-E Joystick
2. USB Cable
3. 36V Power supply with cable
5. This manual

MOUNTING & OPERATING CONDITION

1. The unit must be mounted with 4 Screws securely on a flat surface before operating.
2. Keep a minimum of 5 cm distance around the unit from any part.
3. Keep environmental temperature below 40°C max. Use only in dry environment.
4. Variants delivered without GRIP: Install your grip (TM Hotas / VPC Mongoos T-50),
please refer to Chapter 3: GRIP INSTALLATION

FIRST START / ELECTRICAL CONNECTION

1. Connect the provided power supply to Power Plug.
Attention! AC Main power plug must be unplugged
2. Connect the CLS-E Joystick with your computer via the provided USB cable.
3. Connect the delivered AC main power plug to the Power Supply and connect the power cable to the AC-power outlet. The calibration and initialization sequence will start automatically. Axis are moving across their range.



**DO NOT DISTURB THIS SEQUENCE UNTIL THE JOYSTICK IS CENTERED!
THIS SEQUENCE IS REPEATED EVERY TIME WHEN POWER IS APPLIED.**

3 GRIP INSTALLATION

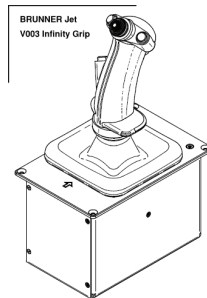
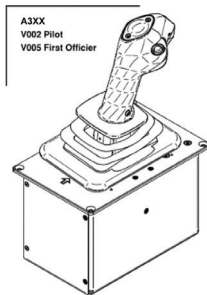
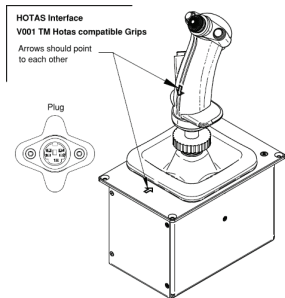

Custom Grip
V004 with DSUB15 interface

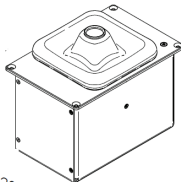
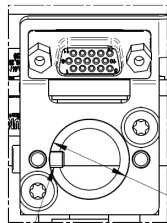
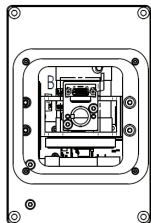

$\varnothing 20\ H7 \begin{matrix} +0,021 \\ 0 \end{matrix}$

Use a M4x10 screw to fix your own grip

detail B

X3 Pin-No.	Signal
1	VCC
2	IN1
3	IN2
4	IN3
5	IN4
6	IN5
7	IN6
8	GND
9	IN7
10	IN8
11	IN9
12	IN10
13	IN11
14	IN12
15	GND
Housing	GND

USB Driver

USB Driver is installed automatically when the Joystick is connected to your computer via USB and power is applied the first time. CLS-E Joystick (TM Hotas, A3xx, Jet, Custom) must show up in Windows as Game Controller. In standalone mode (CLS2SIM SW is not installed) the Hat Switch is assigned as Hardware Trim.Switch is assigned as Hardware Trim.



CLS2SIM (V 4.26.3 or later)

For enabling additional Control Loading Features download and install CLS2Sim (win32 application): <http://www.brunner-innovation.swiss/media>
If the optional CLS2Sim Software is installed all axes are mapped by the software itself.

IN THIS CASE THE USB X-AXIS (ROLL) AND Y-AXIS (PITCH) MAPPING FOR THE CLS-E JOYSTICK MUST BE DISABLED IN THE SIMULATION SOFTWARE.

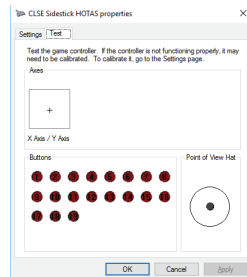

DUAL JOYSTICK SETUP / SYNCHRONIZATION

In case of using 2 CLS-E Joystick (MCC Configuration), connect a standard RJ45 Cat5 Ethernet cable on the “CANopen” connector between the units. All necessary settings for self-synchronization is done automatically at the first power up of the devices (See Chapter 6 Wiring Diagram on page 32).

Read the manual and help file in CLS2Sim for additional information.
Contact us under following e-mail in case of troubles or questions support@brunner-innovation.swiss

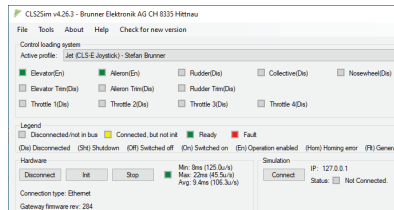

SPECIFICATION

Peak Force:	Pitch: 4.2 Nm / 3.1 lbs-ft Roll: 4.2 Nm / 3.1 lb-ft
Travel:	+/- 20.5°
Grip:	V001 TM Hotas Interface, w/o GRIP V002 A3xx Pilot preinstalled V003 BRUNNER Jet preinstalled V004 Custom Grip Interface with DSUB15 I/O V005 A3xx First Officer preinstalled
Interface:	USB (USB-2 Type-B) CAN (RJ45)
Noise Levels:	< 40dB(A)
Power:	300W peak (no fan)
Operating-Voltage:	19 - 48VDC (ext. Power supply included)
Weight:	4 kg / 11 lb

DIMENSIONS (V001)

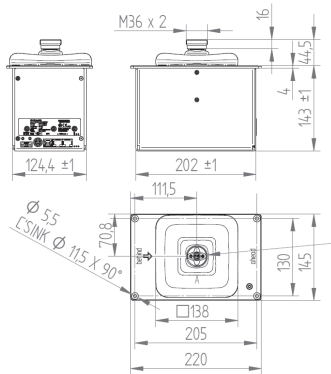

DISPOSAL NOTES

The appliance contains reusable materials and should be disposed of properly not simply with unsorted household refuse. Appliances which are no longer needed must be disposed of in a professional and appropriate way, in accordance with the current local regulations and laws.



INHALTSÜBERSICHT CLS-E JOYSTICK DEUTSCH

1 SICHERHEITS UND WARNHINWEISE	9
2 INSTALLATIONSANLEITUNG	10
3 GRIP INSTALLATION	11
4 SOFTWARE INSTALLATION	12
5 TECHNISCHE DATEN UND ENTSORGUNGSHINWEIS	13
6 WIRING DIAGRAM	32

EINSATZBEREICH DES GERÄTES. DAS GERÄT DARF NUR FÜR DIE SIMULATION VON KONTROLLDRÜCKEN, KONTROLLE EINES LUFTFAHRZEUGS IN EINER FLUGSIMULATION IN VERBINDUNG MIT EINEM PC FÜR DEN HEIMANWENDER VERWENDET WERDEN. IM WEITEREN IST DAS GERÄT NICHT GEEIGNET FÜR DEN BETRIEB IN EXPLOSIONSGEFÄHRDETEN BEREICHEN.

GENERELL. DER RICHTIGE UND SICHERE BETRIEB DER HARDWARE SETZT KORREKTEN UND PROFESSIONELLEN TRANSPORT, LAGERUNG, MONTAGE UND SORGFÄLTIGEN BETRIEB UND UNTERHALT VORAUS.

SORGFÄLTIGER UMGANG. NICHT FALLEN LASSEN. STROM UND KOMMUNIKATIONSKABEL MÜSSEN VOR DEM UMPLATZIEREN/ HANTIEREN GETRENNT WERDEN.

WARNUNG! HALTEN SIE DEN GRIP-BEREICH FREI, WENN DAS GERÄT MIT DER SPANNUNGSVERSORUNG VERBUNDEN WIRD. IMMER WARTEN BIS DIE AUTOMATISCHE INITIALISIERUNGS-SEQUENZ BEENDET IST

WARNUNG! HALTEN SIE TIERE FERN VOM SYSTEM!

WARNUNG! CONTROL LOADING SYSTEME SIND KEINE SPIELZEUGE. KINDER UNTER 16 JAHREN DÜRFEN DIE HARWDARE NICHT OHNE DIE AUFSICHT EINES ERWACHSENEN BEDIENEN. BEI BESTIMMTEN EINSTELLUNGEN, ODER IM FEHLERFALL, KANN SICH DIE HARDWARE OHNE WARNUNG IN EINE BELIEBIGE RICHTUNG BEWEGEN.

WARNUNG! ABDECKUNG NIEMALS ENTFERNEN. DAS GERÄT DARF NIEMALS OHNE ABDECKUNG BETRIEBEN WERDEN!

WARNUNG! DAS GERÄT MUSS VOR DER INBETRIEBNAHME SICHER AUF EINER FLACHEN UND STABILEN UNTERLAGE MONTIERT SEIN!

WARNUNG! VORSICHT STROMSCHLAG / BRANDGEFAHR! DIE STECKDOSE MUSS VORSCHRIFTMÄSSIG GEERDET UND ELEKTRISCH ABGESICHERT SEIN. KEINE ANDEREN NETZGERÄTE ALS DIE VON BRUNNER GELIEFERT ODER EMPFOHLEN VERWENDEN.

WARNUNG! NUR FÜR DEN INNENBEREICH. DAS GERÄT NICHT FEUCHTIGKEIT, FLÜSSIGKEITEN ODER WÄRME AUSSETZEN.

KEINE REPARATUR ODER ÖFFNUNG. DIE HARDWARE DARF NUR VON BRUNNER GEÖFFNET UND REPARIERT WERDEN (LEBENSZEITSCHMIERUNG)!

WARNUNG! BEVOR SIE DRITT-PERSONEN DAS BEDIENEN DER HARDWARE GESTATTEN, STELLEN SIE SICHER, DASS DIESE DRITT-PERSONEN ALLE WARNUNGEN GELESEN, VERSTANDEN UND AKZEPTIERT HABEN.

WICHTIGE ERGONOMISCHE INFORMATION! WIEDERKEHRENDE BEWEGUNGEN ÜBER LÄNGERE ZEITRÄUME UNTER VERWENDUNG EINES FALSCH EINGERICHTETEN ARBEITSPLATZES, INKORREKTE KÖRPERHALTUNG UND SCHLECHTE ARBEITSANGEWÖHNHEITEN KÖNNEN DURCH FEHLBELASTUNG VON NERVEN, SEHNEN ODER MUSKELN ZU BESCHWERDEN ODER VERLETZUNGEN FÜHREN.

DURCH DIE NICHT-BEACHTUNG DIESER WARNUNGEN KÖNNEN IM FEHLERFALL ODER BEI STÖRUNGEN VERLETZUNGEN VERURSACHT WERDEN.

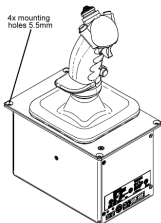

GENERELL

Box vorsichtig öffnen und Verpackungsmaterial entfernen.
Folgendes Material ist enthalten:

1. CLS-E Joystick
2. USB Kabel
3. 36V Netzgerät mit Kabel
4. Dieses Manual

INSTALLATION & BETRIEBSBEDINGUNGEN

1. Das Gerät muss mit 4 Schrauben oder 2 Schraubklemmen auf eine stabile flache Unterlage montiert werden.
2. Mindestens 5 cm Abstand um das komplette Gerät einhalten
3. Umgebungstemperatur unter 40°C halten. Nur in trockener Umgebung verwenden.
4. Für Varianten ohne Grip:

Grip installieren (TM Hotas / VPC MongoosT-50),

siehe auch Kapitel 3 GRIP INSTALLATION

ERSTER START

1. Mitgeliefertes Netzgerät an Power Stecker anschliessen.

Achtung! Netzgerät darf nicht mit Steckdose verbunden sein!

2. Mitgeliefertes USB Kabel anschliessen und mit PC verbinden.
3. Power Kabel mit Netzgerät verbinden und an Wechselstrom Steckdose einstecken.
Die Kalibrierung und Initialisierung läuft automatisch ab.



DEN BEWEGUNGSABLAUF NICHT STÖREN BIS SEQUENZ BEENDET IST (JOYSTICK IN MITTELSTELLUNG). DIESE SEQUENZ LÄUFT NACH JEDEM NEUANLEGEN DER SPANNUNGSVERSORUNG AB.

3 GRIP INSTALLATION

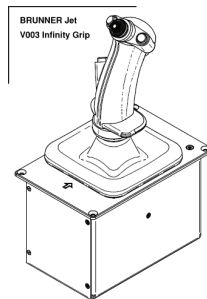
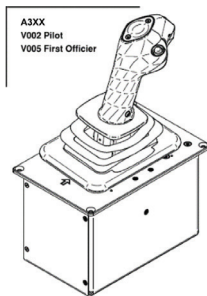
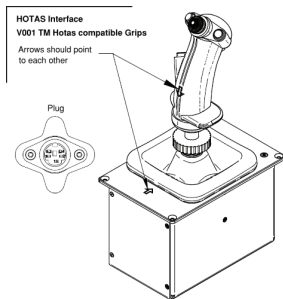

Custom Grip
V004 with DSUB15 interface

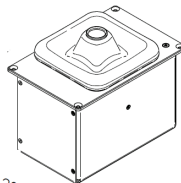
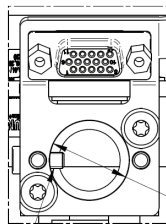
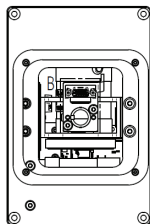

Use a M4x10 screw to fix your own grip

X3 Pin-No.	Signal
1	VCC
2	IN1
3	IN2
4	IN3
5	IN4
6	IN5
7	IN6
8	GND
9	IN7
10	IN8
11	IN9
12	IN10
13	IN11
14	IN12
15	GND
Housing	GND

USB Treiber

Der USB Treiber wird automatisch beim ersten Einschalten des Gerätes installiert. CLS-E Joystick (TM Hotas, A3xx, Jet, Custom) wird in Windows als Game Controller angezeigt. Im Stand-Alone Mode (ohne CLS2SIM SW Installation) ist der Hat Switch als Hardware Trim gemapped.



CLS2SIM (V 4.26.3 oder später)

Für die erweiterten Control Loading Features bitte CLS2SIM (Win32 Anwendung) unter <http://www.brunner-innovation.swiss/media> downloaden und installieren. Sobald die optionale CLS2SIM Software installiert ist werden alle Achsen automatisch gemapped.

IN DIESEM FALL MUSS DAS USB-MAPPING FÜR X-AXIS (ROLL) UND Y-AXIS (PITCH) FÜR DAS CLS-E JOYSTICK IN DER SIMULATIONS-SOFTWARE DEAKTIVIERT WER DEN.

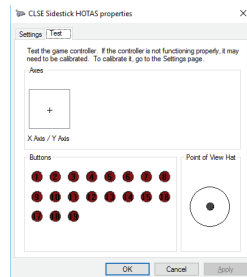

DUAL JOYSTICK SETUP / SYNCHRONIZATION

Falls 2 CLS-E Joystick im Einsatz sind (MCC Konfiguration), ein RJ45 Standard Cat5 Kabel an der jeweiligen "CANopen" Buchse der Geräte einstecken und die beiden Geräten verbinden. Alle nötigen Einstellungen für die Selbstsynchronisation werden automatisch nach dem ersten Einschalten der Speisung vorgenommen (siehe Kapitel 6. Wiring Diagrams auf Seite 32). Lesen sie das Help-File in CLS2SIM (F1) für zusätzliche Informationen. Kontaktieren sie uns bei Fragen oder Problemen unter folgender E-Mail: support@brunner-innovation.swiss

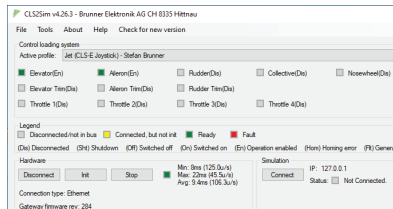

SPEZIFIKATION

Max. Kraft:	Pitch: 4.2 Nm / 3,1 lbs-ft Roll: 4.2 Nm / 3.1 lb-ft
Verfahrweg:	+/- 20.5°
Grip:	V001 TM Hotas Interface, ohne Grip V002 A3xx Pilot vorinstalliert V003 BRUNNER Jet vorinstalliert V004 Custom Grip mit DSUB15 I/O V005 A3xx First Officer vorinstalliert
Schnittstellen:	USB (USB-2 Type-B) CAN (RJ45)
Lärmpegel:	< 40dB(A)
Leistung	300W Peak (ohne Lüfter)
Betriebs- Spannung:	19 - 48VDC (Netzteil im Lieferumfang)
Gewicht:	4 kg / 11 lb

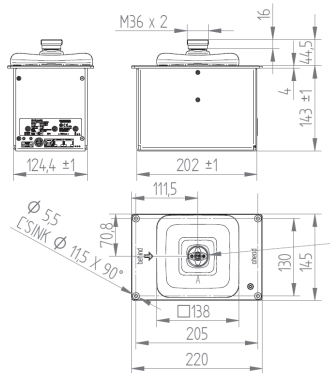
ABMESSUNGEN (V001)**ENTSORGUNGSHINWEIS**

Das Gerät enthält wertvolle Materialien und ist einer vom unsortierten Siedlungsabfall getrennten Erfassung zuzuführen. Die Entsorgung von ausgedienten Geräten muss fach- und sachgerecht nach den örtlich geltenden Vorschriften und Gesetzen erfolgen.



CONTENU CLS-E JOYSTICK FRANÇAIS

1 CONSIGNES DE SECURITE ET AVERTISSEMENTS	15
2 MANUEL D'INSTALLATION	16
3 INSTALLATION DE LA POIGNÉE	17
4 INSTALLATION LOGICIELLE	18
5 NOTES DE DONNÉES ET ÉLIMINATION TECHNIQUES	19
6 SCHÉMA DE CÂBLAGE	32

DOMAINE D'UTILISATION DE L'APPAREIL. L'APPAREIL DOIT SEULEMENT ETRE UTILISE POUR LA SIMULATION DE PRESSIONS DE CONTRÔLE, LE CONTRÔLE D'UN AVION DANS LE CADRE D'UNE SIMULATION DE VOL POUR UTILISATEUR DOMESTIQUE. EN OUTRE, L'APPAREIL N'EST PAS ADAPTE A UNE UTILISATION DANS DES ZONES A RISQUES D'EXPLOSION.

GENERALITES POUR FONCTIONNER DE MANIERE SURE ET FIABLE, LE MATERIEL DOIT ETRE TRANSPORTE, STOCKE, MONTE CORRECTEMENT PAR DES PERSONNELS COMPETENTS, IL DOIT AUSSI ETRE MIS EN SERVICE ET ENTRETENU AVEC PRECAUTION.

MANIPULER AVEC PRÉCAUTION. NE PAS LAISSER TOMBER. LES CÂBLES D'ALIMENTATION ET DE COMMUNICATION DOIVENT ÊTRE DÉBRANCHÉS AVANT TOUT DÉPLACEMENT DE L'APPAREIL/TOUTE OPÉRATION DE MAINTENANCE.

AVERTISSEMENT! GARDEZ LIBRE D'ACCÈS LA ZONE RUDDER (ZONE DE PRÉVENTION) LORSQUE L'APPAREIL EST BRANCHÉ À L'ALIMENTATION ÉLECTRIQUE. TOUJOURS ATTENDRE LA FIN DE LA SEQUENCE D'INITIALISATION AUTOMATIQUE

ATTENTION! ÉLOIGNEZ LES ANIMAUX DOMESTIQUES SYSTEM!

AVERTISSEMENT! LES SYSTEMES DE CHARGEMENT DE CONTRÔLE NE SONT PAS DES JOUETS. LES ENFANTS DE MOINS DE 16 ANS NE PEUVENT PAS UTILISER LE MATERIEL SANS LA SUPERVISION D'UN ADULTE. AVEC CERTAINS RÉGLAGES, OU EN CAS DE DÉFAUT, IL EST POSSIBLE QUE LE MATÉRIEL SE DÉPLACE DE MANIÈRE INATTENDUE DANS N'IMPORTE QUELLE DIRECTION.

AVERTISSEMENT! NE JAMAIS RETIRER LE COUVERCLE. L'APPAREIL NE DOIT JAMAIS ETRE UTILISE SANS COUVERCLE !

AVERTISSEMENT! AVANT SA MISE EN SERVICE, L'APPAREIL DOIT ÊTRE MONTÉ ET SÉCURISÉ SUR UNE SURFACE PLANE ET STABLE !

AVERTISSEMENT, COURANT ÉLECTRIQUE! ATTENTION RISQUE D'ELECTROCUTION / RISQUE D'INCENDIE !

LA PRISE DOIT ETRE MISE A LA TERRE ET PROTEGEE ELECTRIQUEMENT, CONFORMEMENT A LA REGLEMENTATION.

NE PAS UTILISER D'APPAREIL DE SECTEUR AUTRE QUE CELUI FOURNI OU RECOMMANDÉ PAR BRUNNER

AVERTISSEMENT, ENVIRONNEMENT! UNIQUEMENT POUR UNE UTILISATION EN INTÉRIEUR. L'APPAREIL NE DOIT PAS ÊTRE EXPOSÉ À L'HUMIDITÉ, À DES LIQUIDES OU À LA CHALEUR.

NE PAS EFFECTUER DE RÉPARATION NI OUVRIR L'APPAREIL. LE MATÉRIEL NE PEUT ÊTRE OUVERT ET RÉPARÉ QUE PAR BRUNNER (APPAREIL LUBRIFIÉ POUR TOUTE SA DURÉE DE VIE) !

AVERTISSEMENT! AVANT DE PERMETTRE À DES TIERS D'UTILISER LE MATÉRIEL, ASSUREZ-VOUS QUE CES PERSONNES ONT BIEN LU, COMPRIS ET ACCEPTÉ TOUS LES AVERTISSEMENTS.

CRITÈRES D'ERGONOMIE IMPORTANTS! DES MOUVEMENTS RÉPÉTITIFS EFFECTUÉS PENDANT DE LONGUES PÉRIODES DE SERVICE SUR UN POSTE DE TRAVAIL MAL AGENCÉ, DES POSTURES INADÉQUATES ET DE MAUVAISES HABITUDES DE TRAVAIL PEUVENT ENTRAÎNER DES DOULEURS OU DES BLESSURES SUITE À DES SOLlicitATIONS INAPPROPRIÉES DES NERFS, DES TENDONS OU DES MUSCLES.

LE NON-RESPECT DE CES AVERTISSEMENTS PEUT PROVOQUER DES BLESSURES EN CAS DE PANNE OU DE DEFAUTS.

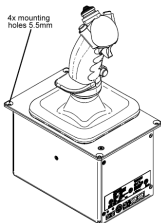

GÉNÉRALITÉS

Ouvrir la boîte avec précaution et retirer les matériaux d'emballage.

Le matériel suivant est fourni:

1. Joystick CLS-E
2. Câble USB
3. Alimentation 36V avec câble
5. Ce manuel

CONDITIONS D'INSTALLATION ET D'UTILISATION

1. L'unité doit être montée avec 4 vis solidement sur une surface plane avant de fonctionner.
2. Gardez une distance d'au moins 5 cm autour de l'appareil de toute pièce.
3. Maintenez la température ambiante en dessous de 40 ° C max. Utilisez uniquement dans un environnement sec.
4. Variantes livrées sans GRIP: Installez votre poignée (TM Hotas / VPC Mongoos T-50), veuillez vous référer au Chapitre 3: INSTALLATION DE LA POIGNÉE



PREMIER DEMARRAGE

1. Connectez l'alimentation fournie à la prise d'alimentation.
Attention! La prise d'alimentation secteur doit être débranchée
2. Connectez le Joystick CLS-E à votre ordinateur via le câble USB fourni.
3. Branchez la fiche d'alimentation secteur CA fournie au bloc d'alimentation et connectez le câble d'alimentation au Prise de courant alternatif. La séquence d'étalonnage et d'initialisation démarre automatiquement. Les axes se déplacent sur leur aire de répartition.

**NE PAS DÉRANGER CE SEQUENZ JUSQU'À CE QUE LE JOYSTICK EST CENTRÉ!
CETTE SÉQUENCE EST RÉPÉTÉ CHAQUE FOIS QUAND L'ALIMENTATION EST APPLIQUÉE.**

3 INSTALLATION DE LA POIGNÉE

17

BRUNNER
dedication + innovation

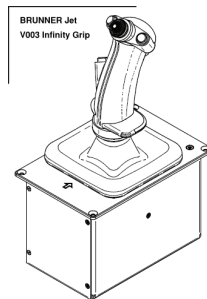
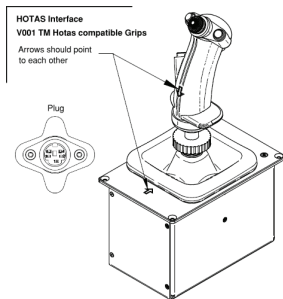

Custom Grip
V004 with DSUB15 interface

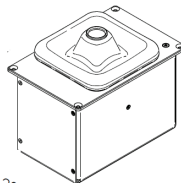
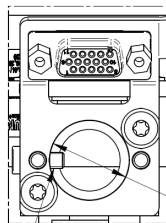
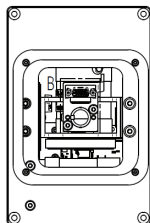

Use a M4x10 screw to fix your own grip

detail B

X3 Pin-No.	Signal
1	VCC
2	IN1
3	IN2
4	IN3
5	IN4
6	IN5
7	IN6
8	GND
9	IN7
10	IN8
11	IN9
12	IN10
13	IN11
14	IN12
15	GND
Housing	GND

PILOTE USB

Le pilote USB est installé automatiquement lorsque le joystick est connecté à votre ordinateur via USB et que l'alimentation est appliquée la première fois. Le joystick CLS-E (TM Hotas, A3xx, Jet, Custom) doit apparaître dans Windows en tant que contrôleur de jeu. En mode autonome (CLS2SIM SW n'est pas installé), le commutateur de chapeau est affecté en tant que garniture matérielle.



CLS2SIM (V 4.26.3 ou version plus récente)

For enabling additional Control Loading Features download and install CLS2Sim (win32 application): <http://www.brunner-innovation.swiss/media>
If the optional CLS2Sim Software is installed all axes are mapped by the software itself.

IN THIS CASE THE USB X-AXIS (ROLL) AND Y-AXIS (PITCH) MAPPING FOR THE CLS-E JOYSTICK MUST BE DISABLED IN THE SIMULATION SOFTWARE.

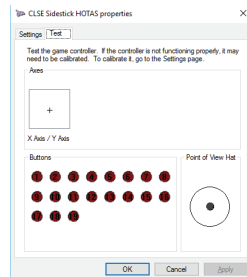

CONFIGURATION DOUBLE JOYSTICK / SYNCHRONISATION

Si deux CLS-E Joystick sont utilisées (configuration MCC), connectez un câble Cat5 standard RJ45 standard au connecteur „CANopen“ entre les deux appareils (voir le chapitre 6. Schémas de câblage à la page 32). Tous les réglages nécessaires à la synchronisation automatique sont effectués automatiquement après la première alimentation de l'alimentation.

Consultez le fichier d'aide dans CLS2SIM (F1) pour plus d'informations. Contactez-nous si vous avez des questions ou des problèmes à l'adresse e-mail support@brunner-innovation.swiss

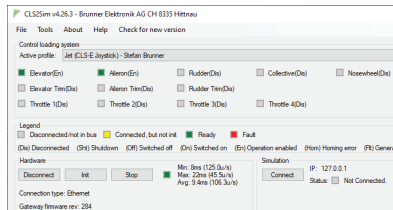

SPECIFICATION

Peak Force:	Pitch: 4.2 Nm / 3.1 lbs-ft Roll: 4.2 Nm / 3.1 lb-ft
Traverser:	+/- 20.5°
Poignée:	V001 TM Hotas Interface, w/o GRIP V002 A3xx Pilot pre-installé V003 BRUNNER Jet pre-installé V004 Custom Grip Interface avec DSUB15 I/O V005 A3xx First Officer pre-installé
Interface:	USB (USB-2 Type-B) CAN (RJ45)
Niveaux de bruit:	< 40dB(A)
Puissance:	300W Peak (no fan)
Tension de fonctionnement:	19 - 48VDC (ext. Alimentation)
Poids:	4 kg / 11 lb

DIMENSIONS (V001)

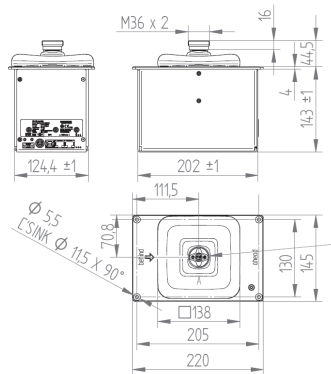

PROTECTION DE L'ENVIRONNEMENT

L'appareil contient des matériaux de valeur et est à amener à un lieu de recyclage spécial. L'élimination d'anciens appareils est à réaliser correctement en respectant les prescriptions et lois locales en vigueur.



CONTENUTI CLS-E JOYSTICK ITALIANO

1 NORME DI SICUREZZA E AVVERTENZE	21
2 GUIDA ALL'INSTALLAZIONE	22
3 INSTALLAZIONE DELLA MANOPOLA	23
4 INSTALLAZIONE DEL SOFTWARE	24
5 NOTE DATI TECNICI E SMALTIMENTO	25
6 SCHEMA DI CABLAGGIO	32

AMBITO DI IMPIEGO DEL DISPOSITIVO. IL DISPOSITIVO PUÒ ESSERE UTILIZZATO SOLO PER LA SIMULAZIONE DI PROVE DI VERIFICA E CONTROLLO DI UN AEROMOBILE IN UNA SIMULAZIONE DI VOLO PER LA CASA UTENTE. INOLTRE L'APPARECCHIO NON È ADATTO PER L'USO IN AREE A RISCHIO DI ESPLOSIONE.

GENERALITÀ. IL FUNZIONAMENTO CORRETTO E SICURO DELL'HARDWARE PRESUPPONE UN TRASPORTO, UNO STOCCAGGIO, UN MONTAGGIO ALTRETTANTO CORRETTI E PROFESSIONALI NONCHÉ UN USO E UNA MANUTENZIONE ACCURATI.

USO ACCURATO. NON FAR CADERE IL DISPOSITIVO.

I CAVI DI COMUNICAZIONE E ALIMENTAZIONE DEVONO ESSERE STACCATI PRIMA DI ESSERE SPOSTATI/MANIPOLATI.

ATTENZIONE! MANTENERE LIBERA L'AREA DEL RUDDER QUANDO IL DISPOSITIVO VIENE COLLEGATO ALLA RETE ELETTRICA. ATTENDERE SEMPRE FINO A QUANDO NON TERMINA LA SEQUENZA DI INIZIALIZZAZIONE AUTOMATICA

ATTENZIONE! TENERE GLI ANIMALI DOMESTICI LONTANO DAL SISTEMA!

ATTENZIONE! I SISTEMI DI CARICAMENTO DEGLI STRUMENTI DI CONTROLLO NON SONO GIOCATTOLI. I BAMBINI AL DI SOTTO DEI 16 ANNI NON POSSONO UTILIZZARE L'HARDWARE SENZA LA SUPERVISIONE DI UN ADULTO. IN PRESENZA DI DETERMINATE IMPOSTAZIONI O IN CASO DI GUASTO, L'HARDWARE SI PUÒ MUOVERE IN QUALSIASI DIREZIONE INAVVERTITAMENTE.

ATTENZIONE! NON RIMUOVERE MAI IL COPERCHIO. IL DISPOSITIVO NON DEVE MAI ESSERE UTILIZZATO SENZA COPERCHIO!

ATTENZIONE! PRIMA DEL PRIMO UTILIZZO, IL DISPOSITIVO DEVE ESSERE SALDAMENTE MONTATO SU UNA SUPERFICIE PIANA E STABILE!

ATTENZIONE, EROGAZIONE DI CORRENTE! ATTENZIONE, SCOSSA ELETTRICA / PERICOLO D'INCENDIO!

LA PRESA DI CORRENTE DEVE ESSERE MESSA A TERRA E PROTETTA ELETTRICAMENTE SECONDO LE ISTRUZIONI.

NON UTILIZZARE ADATTATORI DIVERSI DA QUELLI IN DOTAZIONE O RACCOMANDATI DA BRUNNER

ATTENZIONE ALL'AMBIENTE CIRCOSTANTE! SOLO PER USO INTERNO. NON ESPORRE IL DISPOSITIVO A UMIDITÀ, LIQUIDI O FONTI DI CALORE.

NON RIPARARE O APRIRE. L'HARDWARE PUÒ ESSERE APERTO E RIPARATO SOLO DA BRUNNER (LUBRIFICAZIONE A VITA)!

ATTENZIONE! PRIMA DI CONSENTIRE A TERZI DI UTILIZZARE L'HARDWARE, ASSICURARSI CHE QUESTE

TERZE PERSONE ABBIANO LETTO, COMPRESO E ACCETTATO TUTTE LE AVVERTENZE.

IMPORTANTI INFORMAZIONI ERGONOMICHE! MOVIMENTI RIPETITIVI PER PERIODI PROLUNGATI ALL'INTERNO DI UNA POSTAZIONE DI LAVORO ALLESTITA IN MANIERA NON IDONEA, POSTURA SCORRETTA E CATTIVE ABITUDINI DI LAVORO POSSONO PORTARE A DISTURBI O LESIONI DOVUTI ALLO STRESS ECCESSIVO A CARICO DI NERVI, TENDINI O MUSCOLI.

IN CASO DI GUASTO O MALFUNZIONAMENTI, LA MANCATA OSSERVANZA DI QUESTE AVVERTENZE PUÒ PROVOCARE LESIONI.



GENERALITÀ

Aprire la scatola con cautela e rimuovere il materiale di imballaggio.

Il seguente materiale è incluso nella scatola:

1. CLS-E Joystick
2. Cavo USB
3. Alimentazione 36V con cavo
5. Questo manuale

INSTALLAZIONE E CONDIZIONI DI UTILIZZO

1. Il dispositivo deve essere montato con 4 viti (non incluso) a vite su una superficie piana e stabile.
2. Ogni componente deve essere posto ad almeno 5 cm di distanza dal dispositivo.
3. Mantenere la temperatura dell'ambiente sotto i 40°C. Utilizzare solo in un ambiente secco.
4. Varianti consegnate senza GRIP: Installa il tuo grip (TM Hotas / VPC Mongoos T-50), fai riferimento al **Capitolo 3: INSTALLAZIONE DELLA MANOPOLA**

PRIMO AVVIO

1. Collegare l'alimentatore in dotazione alla spina di alimentazione.

Attenzione! CA La spina di alimentazione principale deve essere scollegata

2. Collegare il joystick CLS-E al computer tramite il cavo USB in dotazione.
3. Collegare la spina di alimentazione CA in dotazione all'alimentatore e collegare il cavo di alimentazione a presa di corrente alternata. La sequenza di calibrazione e inizializzazione inizierà automaticamente. L'asse si sta muovendo attraverso la loro portata.



**NON DISTURBARE QUESTA SEQUENZA FINO A CHE IL JOYSTICK È CENTRATO!
QUESTA SEQUENZA È RIPETUTO OGNI VOLTA QUANDO È APPLICATA L'ALIMENTAZIONE.**

3 INSTALLAZIONE DELLA MANOPOLA

23

BRUNNER
dedication + innovation

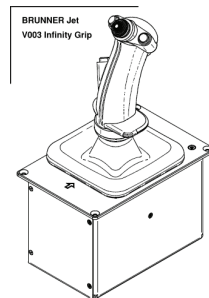
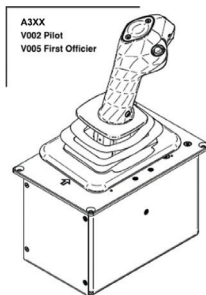
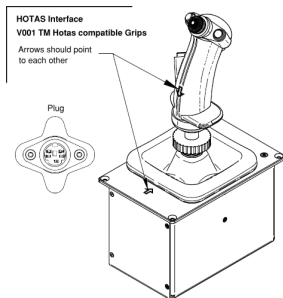

Custom Grip
V004 with DSUB15 interface

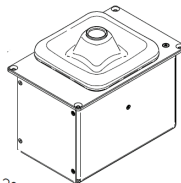
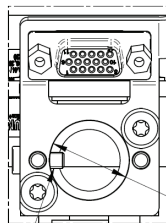
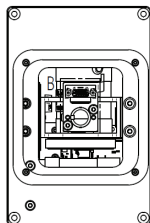

Use a M4x10 screw to fix your own grip

detail B

X3 Pin-No.	Signal
1	VCC
2	IN1
3	IN2
4	IN3
5	IN4
6	IN5
7	IN6
8	GND
9	IN7
10	IN8
11	IN9
12	IN10
13	IN11
14	IN12
15	GND
Housing	GND

DRIVER USB

Il driver USB viene installato automaticamente quando il Joystick è collegato al computer tramite USB e l'alimentazione viene applicata la prima volta. Il Joystick CLS-E (TM Hotas, A3xx, Jet, Custom) deve essere visualizzato in Windows come controller di gioco. In modalità standard (CLS2SIM SW non è installato) HAT Switch è assegnato come Hardware Trim.



CLS2Sim (V 4.26.3 o successiva)

Per le caratteristiche avanzate del caricamento degli strumenti di controllo è possibile scaricare CLS2SIM (applicazione win32) all'indirizzo <http://www.brunner-innovation.swiss/media>. Se è installato il software CLS2Sim opzionale, tutti gli assi vengono mappati dal software stesso.

IN QUESTO CASO IL MAPPING USB X-AXIS (ROLL) E Y-AXIS (PITCH) PER IL JOYSTICK CLS-E DEVE ESSERE DISABILITATO NEL SOFTWARE DI SIMULAZIONE.

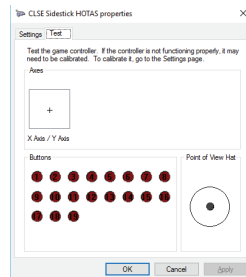

SETUP DUAL JOYSTICK / SINCRONIZZAZIONE

In caso di utilizzo di 2 Joystick CLS-E (configurazione MCC), collegare uno standard Cavo Ethernet RJ45 Cat5 sul connettore „CANopen“ tra le unità. Tutte le impostazioni necessarie per l'auto-sincronizzazione vengono eseguite automaticamente al primo avvio dei dispositivi (vedere il capitolo 6 Schema di cablaggio a pagina 32).

Per ulteriori informazioni, leggere il file di guida in CLS2sim (F1).

In caso di domande o problemi, contattare il seguente indirizzo e-mail support@brunner-innovation.swiss

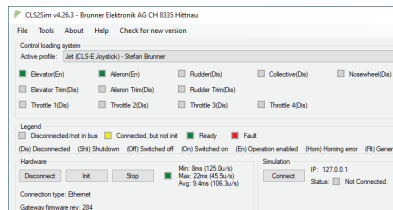

SPECIFICHE

Potere max:	Pitch: 4.2 Nm / 3.1 lbs-ft Roll: 4.2 Nm / 3.1 lb-ft
Attraversare:	+/- 20.5°
Grip:	V001 TM Hotas Interfaccia, w/o GRIP V002 A3xx Pilot pre installato V003 BRUNNER Jet pre installato V004 Custom Grip Interfaccia con DSUB15 I/O V005 A3xx First Officer pre installato
Interfaccia:	USB (USB-2 Type-B) CAN (RJ45)
Livello di rumore:	< 40dB(A)
Potere:	300W Peak (nessun fan)
Tensione:	19 - 48VDC (ext. Alimentatore incluso)
Peso:	4 kg / 11 lb

DIMENSIONI (V001)

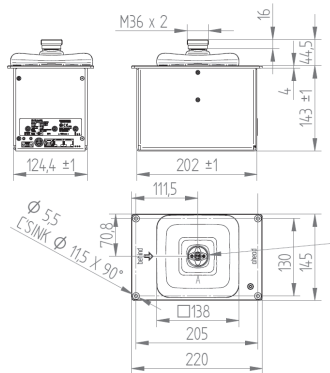

INDICAZIONI PER LO SMALTIMENTO

Indicazioni per lo smaltimento L'apparecchio contiene materiali utili e non va smaltito nella raccolta indifferenziata dei rifiuti, ma portato in appositi centri. Gli apparecchi fuori uso devono essere smaltiti a regola d'arte, conformemente alle norme e alle leggi locali in vigore.



CONTENIDO CLS-E JOYSTICK ESPAÑOL

1 INDICACIONES DE SEGURIDAD Y ADVERTENCIAS	27
2 GUÍA DE INSTALACIÓN	28
3 INSTALACIÓN DE AGARRE	29
4 INSTALACIÓN DEL SOFTWARE	30
5 ESPECIFICACIONES TÉCNICAS E INDICACIONES PARA LA ELIMINACIÓN	31
6 DIAGRAMA DE CABLEADO.....	32

APLICACIÓN DEL DISPOSITIVO. EL DISPOSITIVO SOLO PUEDE UTILIZARSE PARA SIMULAR LA PRESIÓN DE CONTROL Y EL CONTROL DE UNA AERONAVE EN UNA SIMULACIÓN DE VUELO PARA USUARIOS DOMÉSTICOS. ASÍ MISMO, LA UNIDAD NO ES APTA PARA SER UTILIZADA EN AMBIENTES EXPLOSIVOS.

GENERAL. LA OPERACIÓN ADECUADA Y SEGURA DEL «HARDWARE» REQUIERE UN CORRECTO Y PROFESIONAL TRANSPORTE, ALMACENAMIENTO, MONTAJE, MANEJO CUIDADOSO Y MANTENIMIENTO.

MANEJO CUIDADOSO. NO PERMITA QUE SE CAIGA. EL CABLE DE ALIMENTACIÓN Y DE COMUNICACIÓN DEBEN ESTAR DESCONECTADOS ANTES DE MOVERLO/MANEJARLO.

¡ADVERTENCIA! MANTENGA DESPEJADA EL ÁREA DELANTE DEL RUDDER MIENTRAS EL DISPOSITIVO ESTÉ CONECTADO AL SUMINISTRO ELÉCTRICO. ANTES DE UTILIZARLO ESPERE SIEMPRE HASTA QUE SE COMPLETE LA SECUENCIA DE INICIALIZACIÓN AUTOMÁTICA.

¡ADVERTENCIA! ¡NO PERMITA QUE NINGÚN ANIMAL SE ACERQUE AL SISTEMA!

¡ADVERTENCIA! LOS SISTEMAS DE CONTROL DE CARGA NO SON UN JUGUETE. LOS NIÑOS MENORES DE 16 AÑOS NO DEBEN MANEJAR EL «HARDWARE» SIN LA SUPERVISIÓN DE UN ADULTO. EN CASO DE CIERTOS AJUSTES PARTICULARES, O EN CASO DE CUALQUIER ERROR, EL «HARDWARE» PUEDE MOVERSE EN CUALQUIER DIRECCIÓN SIN PREVIO AVISO.

¡ADVERTENCIA! NO RETIRE NUNCA LA CUBIERTA. ¡EL DISPOSITIVO NO DEBE UTILIZARSE NUNCA SIN LA CUBIERTA!

¡ADVERTENCIA! ¡ANTES DE PONERSE EN FUNCIONAMIENTO, EL DISPOSITIVO DEBE ESTAR MONTADO DE FORMA SEGURA SOBRE UNA BASE PLANA Y ESTABLE!

¡ADVERTENCIA! PRECAUCIÓN, ¡PELIGRO DE DESCARGA ELÉCTRICA / INCENDIO! EL ENCHUFE DEBE ESTAR DEBIDAMENTE PUESTO A TIERRA Y ASEGURADO ELÉCTRICAMENTE. NO UTILICE NINGUNA OTRA FUENTE DE ALIMENTACIÓN DISTINTA A LA PROPORCIONADA O RECOMENDADA POR BRUNNER.

¡ADVERTENCIA! SOLO PARA USO EN INTERIORES. NO EXPONGA EL DISPOSITIVO A LA HUMEDAD, A LÍQUIDOS O AL CALOR. NO LO REPARE NI LO ABRA. ¡EL «HARDWARE» SOLO PUEDE SER ABIERTO Y REPARADO POR BRUNNER (LUBRICACIÓN DE POR VIDA)!

¡ADVERTENCIA! ANTES DE PERMITIR QUE TERCERAS PERSONAS MANEJEN EL «HARDWARE», ASEGÚRESE DE QUE DICHAS PERSONAS HAYAN LEÍDO, COMPRENDIENDO Y ACEPTADO TODAS LAS ADVERTENCIAS.

¡INFORMACIÓN ERGONOMICA IMPORTANTE! LOS MOVIMIENTOS REPETITIVOS DURANTE LARGOS PERIODOS DE TIEMPO AL EMPLEAR UN PUESTO DE TRABAJO MAL INSTALADO, UNA POSICIÓN DEL CUERPO INCORRECTA Y UNOS MALOS HÁBITOS DE TRABAJO PUEDEN CAUSAR LESIONES DEBIDAS A SOBRECARGAS EN NERVIOS, TENDONES O MÚSCULOS.

NO SEGUIR ESTAS ADVERTENCIAS PUEDE CAUSAR LESIONES EN CASO DE ERRORES O ERRORES.



GENERAL

Abra con cuidado la caja y retire el material de embalaje.

Se incluye el siguiente material:

1. CLS-E Joystick
2. Cable USB
3. Fuente de alimentación de 36 V con cable
5. Este manual

INSTALACIÓN Y CONDICIONES DE OPERACIÓN

1. El dispositivo debe estar montado con 4 tornillos (no incluido) sobre una superficie plana y estable.
2. Deje una separación de al menos 5 cm alrededor de cualquier parte del dispositivo.
3. Mantenga la temperatura ambiente por debajo de 40 °C.
4. Variantes entregadas sin GRIP: Instale su agarre (TM Hotas / VPC Mongoos T-50), consulte el Capítulo 3: INSTALACIÓN DE AGARRE

PRIMERA PUESTA EN MARCHA

1. Conecte la fuente de alimentación proporcionada al enchufe de alimentación.



¡Atención! El enchufe de alimentación principal de CA debe estar desconectado.

2. Conecte el Joystick CLS-E con su computadora a través del cable USB provisto.
3. Conecte el enchufe de alimentación principal de CA suministrado a la fuente de alimentación y conecte el cable de alimentación al Toma de corriente alterna. La secuencia de calibración e inicialización comenzará automáticamente. El eje se mueve a través de su rango.

¡NO MOLESTES ESTA SECUENCIA HASTA QUE EL JOYSTICK ESTÉ CENTRADO! ESTA SECUENCIA ES REPETIDO CADA VEZ CUANDO SE APLICA LA ENERGÍA.

3 INSTALACIÓN DE AGARRE

29

BRUNNER
dedication + innovation

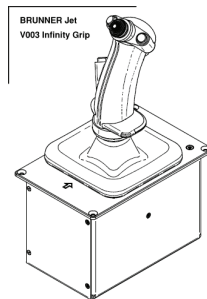
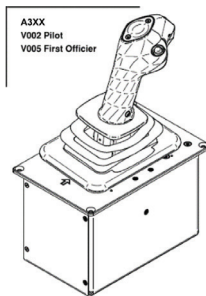
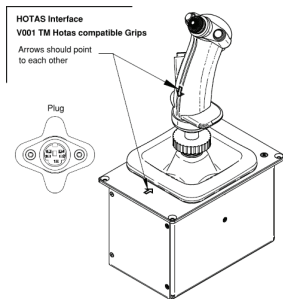

Custom Grip
V004 with DSUB15 interface

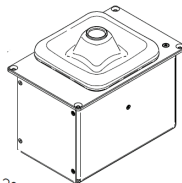
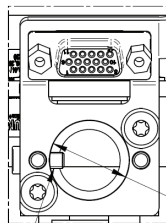
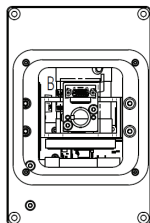

Use a M4x10 screw to fix your own grip

detail B

$\varnothing 20\ H7 \begin{matrix} (+0,021 \\ 0 \end{matrix}$

X3 Pin-No.	Signal
1	VCC
2	IN1
3	IN2
4	IN3
5	IN4
6	IN5
7	IN6
8	GND
9	IN7
10	IN8
11	IN9
12	IN10
13	IN11
14	IN12
15	GND
Housing	GND

CONTROLADOR USB

Controlador USB se instala automáticamente cuando el Joystick se conecta a su computadora a través de USB y la energía se aplica la primera vez. El Joystick CLS-E (TM Hotas, A3xx, Jet, Custom) debe aparecer en Windows como controlador de juego. En el modo independiente (CLS2SIM SW no está instalado), el conmutador Hat se asigna como ajuste de hardware.



CLS2SIM (V 4.26.3 o posterior)

Para las funciones de carga de control extendidas, descargue CLS2SIM <http://www.brunner-innovation.swiss/media>

Si el software opcional CLS2Sim está instalado, el software mismo asigna todos los ejes.

EN ESTE CASO, EL MAPEO X-AXIS USB (ROLLO) Y EL EJE Y (PITCH) PARA EL JOYSTICK CLS-E DEBE DESACTIVARSE EN EL SOFTWARE DE SIMULACIÓN.

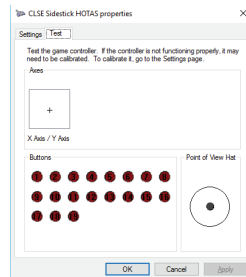

DUAL JOYSTICK SETUP / SYNCHRONIZATION

En caso de utilizar 2 Joystick CLS-E (Configuración MCC), conecte un estándar Cable Ethernet RJ45 Cat5 en el conector „CANopen“ entre las unidades. Todos los ajustes necesarios para la auto-sincronización se realizan automáticamente en el primer encendido de los dispositivos (consulte el Capítulo 6 Diagrama de cableado en la página 32).

Lea el manual y el archivo de ayuda en CLS2Sim para obtener información adicional. Póngase en contacto con nosotros con cualquier pregunta o problema en support@brunner-innovation.swiss

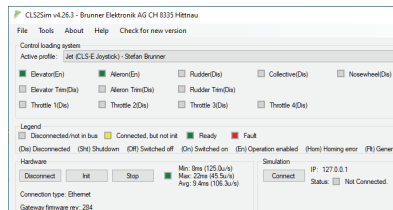

ESPECIFICACIONES

Máx. fuerza:	Pitch: 4.2 Nm / 3.1 lbs-ft Roll: 4.2 Nm / 3.1 lb-ft
Desplazamiento:	+/- 20.5°
Opciones de agarre:	V001 TM Hotas Interface, w/o GRIP V002 A3xx Pilot pre instalado V003 BRUNNER Jet pre instalado V004 Custom Grip Interfaz con DSUB15 I/O V005 A3xx First Officer pre instalado
Interfaces:	USB (USB-2 Type-B) CAN (RJ45)
Nivel de ruido:	< 40dB(A)
Potencia:	300W Peak (sin ventilador)
Operating-Voltage:	19 - 48VDC (ext. Fuente de alimentación incluida)
Peso:	4 kg / 11 lb

DIMENSIONES (V001)

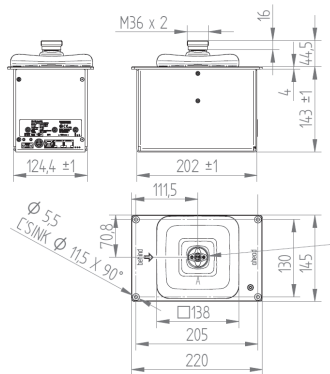

INDICACIONES PARA LA ELIMINACIÓN

Este producto contiene materiales reciclables y no debe desecharse junto con la basura doméstica. La eliminación de los dispositivos que ya no se van a utilizar se debe llevar a cabo de manera profesional y adecuada de acuerdo con las regulaciones y leyes locales. Mediante la correcta eliminación y reciclaje, se cuidan las reservas de materias primas y se garantiza que se respetan todas las disposiciones para la protección de la salud y el medio ambiente.



SINGLE-JOYSTICK OPERATION

CLS-E Joystick



USB 2.0



Power
36V

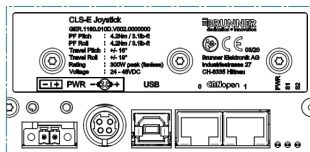

PC



DUAL-JOYSTICK OPERATION

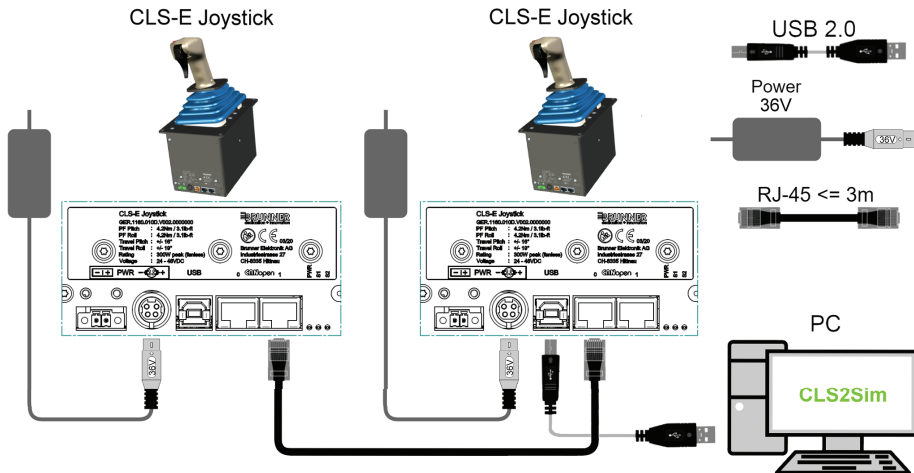

SINGLE JOYSTICK - RUDDER OPERATION

CLS-E Joystick



CLS-E MK II Rudder

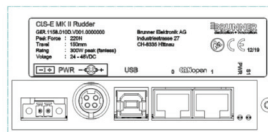

USB 2.0

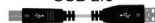

RJ-45 <= 3m



Power
24V



Power
36V

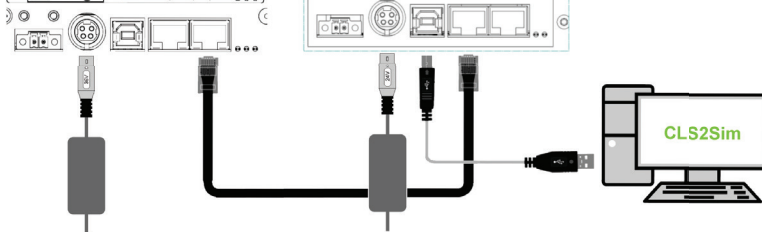
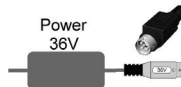

DUAL COCKPIT JOYSTICK - RUDDER OPERATION

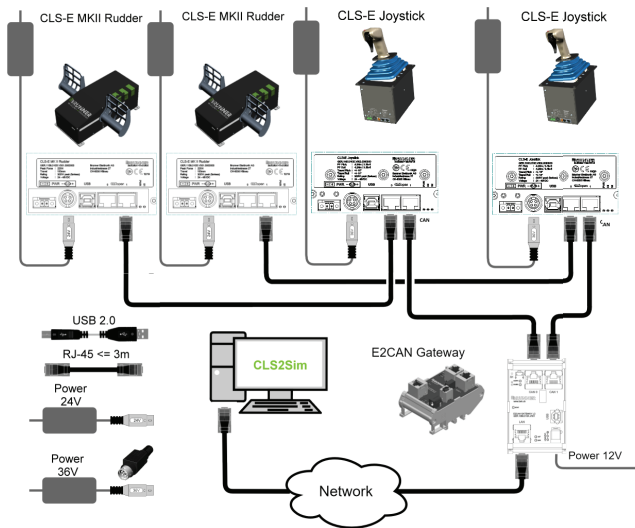

DECLARATION OF CONFORMITY

According to ISO/IEC 17050:2010



We, Brunner Elektronik AG, Industriestrasse 27, CH-8335 Hittnau, Switzerland, declare under our sole responsibility that the following product.

Product description: Control Loading System E-Joystick

Product Name: CLS-E Joystick

Article Number: GER.1160

to which this declaration relates

is in conformity with the essential requirements and provisions of the following Directives of the European Parliament and European Council:

- Electromagnetic Compatibility Directive (EMC) Directive 2014/30/EU of 29 March 2014
 - Low Voltage Directive (LVD) 2014/35/EU of 20 April 2016
 - Restriction of Hazardous Substances (RoHS) Directive 2011/65/EU of 1 July 2011
- The device model GER.1160 is in conformity with the following standards and/or other normative documents:
- EN 55022 Generic standards for Information Technology Equipment (ITE)

EMC

Test name	Standard	Criterion	Verdict
Emission radiated	EN55022	Class B	Complied
Electrostatic discharge (ESD)	EN 61000-4-2	C	Complied
Radiated RF immunity	EN 61000-4-3	A	Complied
Fast transients (Burst)	EN 61000-4-4	B	Complied
Conducted RF immunity	EN 61000-4-6	A	Complied
Power frequency H-field immunity	EN 61000-4-8	A	Complied

HEALTH AND SAFETY

EN 60950-1:2006 + A11:2009 + A12:2011 +A1:2010 +A2:2013
 EN ISO 12100, EN 349

AUTHORIZED REPRESENTATIVE

Brunner Elektronik AG
 Industriestrasse 27
 CH-8335 Hittnau
 Switzerland

This product carries the CE Mark, which was first affixed in 2018.
 Hittnau, 19. February 2018

NOTES

BRUNNER Elektronik AG offers a comprehensive spectrum of products and professional services to customers in Switzerland, across Europe and to all other regions in the world. Tailor-made control systems, drives, motions and simulation products as well as complex total solution assemblies are all designed, produced and tested in-house. By providing dedicated support over the complete life cycle, we guarantee that our solutions provide maximum benefit to our customers.

As an innovative and technology-oriented family business with more than 40 years of experience, we dedicate ourselves to our values and passion for customer satisfaction.

